

COUPE A-A

1.68° Pente d'écoulement

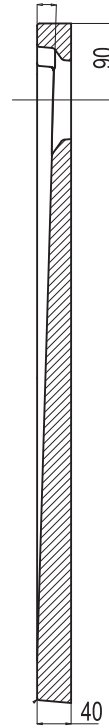

COUPE B-B

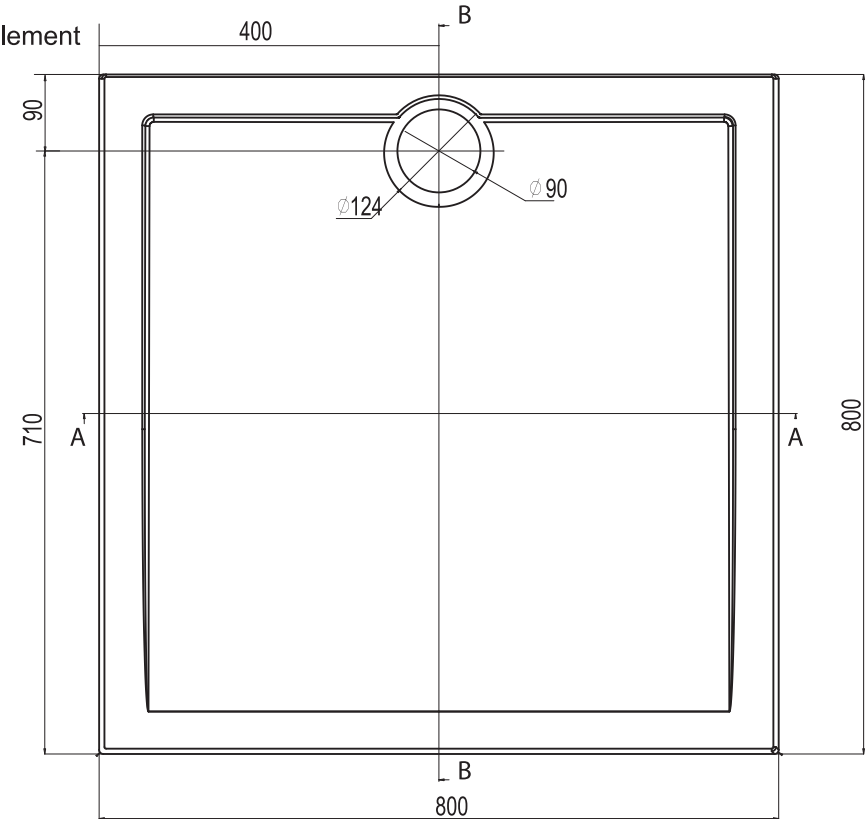

Receveur polybéton
800x800 mm

814053